

**Installation/Operation Manual**  
**for**  
**HD Video Speed Dome Camera**  
V1.0

Please read the operation manual carefully  
before installing and using this unit

## I. Points for Attention

1. Please read the operation manual carefully before installing and operating the product.
2. The product takes power supply of AC24V. The rated input voltage of the camera is marked on the base or other corresponding place.
3. During the course of transportation, storage and installation, the product should be avoided from incorrect operations such as heavy pressing, strong vibration etc., which can cause damage of product as there are sophisticated optical and electronic devices inside the machine.
4. Do not attempt to disassemble the camera. In order to prevent electric shock, do not remove screws or covers. There are no user-serviceable parts inside.

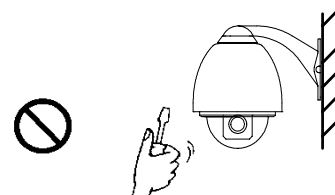

5. Always follow all electrical standards for safety when it is in operation. Adopt the particular power supply which is provided with the unit. RS-485 and video signal should keep enough distance with high voltage equipments and cables when they are in transmission. Precautions for anti-lightning and anti-surging should be taken if necessary.
6. Do not operate it in case temperature, humidity and power supply are beyond the limited stipulations.
7. Do not let the camera aim at the sun or the object with extreme light whatsoever it is switched on or not. Do not let the camera aim at or monitor bright and standstill object for a long time.
8. Do not use aggressive detergent to clean the main body of the camera. Wipe dirt with dry cloth. If needed, mild detergent can be used suitably.
9. Operate the intelligent speed dome camera with great care to avoid shock or vibration. If it operate incorrectly, the Speed Dome could be damaged
10. Be careful to avoid to crash, Never mount the unit on a ceiling that cannot support its weight.

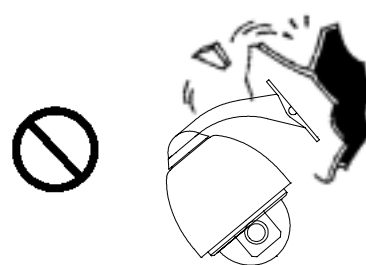

11. If necessary, use a commercial lens cleaning paper to clear the lens windows. Gently wipe the lens window until clean.

## II. Description of Functions

The intelligent dome camera is a hi-tech CCTV product which incorporates high-clarity color camera, panoramic speed-variable PAN/TILT, multifunctional decoder, CPU processor, memory chip into a whole. It can largely reduce connection and installation processes of components in the system, rise up reliability of the system and facilitate installation and maintenance. Therefore it has advantages of beautiful appearance, compact structure and easy operation.

### 1. Integrated Multi-Protocol Decoder

- a. With integrated decoder and multi-protocol, it can integrate 16 kinds of communication protocols in maximum. As its baud rate of communication can be adjusted, it is compatible with many normal systems by easy setup inside the dome camera, so it has stronger versatility.
- b. RS485 serial control: addresses of camera 1-1023.

### 2. Integrated speed-variable PAN/TILT









- a. Turning 360° horizontally and continuously with unlimited positions and an adjustable speed from 0 -- 300°/s; turning 0 - 90° vertically with a speed up to 120°/s.
- b. Running stably at low speed with super lower noise. Pictures have no shaking.
- c. the location precision up to  $\pm 0.1^\circ$ .

### 3. High Intelligent Degree

- a. As much as **128 preset** positions can be preset with powerless memory;
- b. The camera can scan horizontally between two points and scan speed can be modified. The positions of linear scan are optional and the dome camera can scan the range larger or smaller than 180° between any two points with adjustable speed;
- c. Six sets of programmable patrol with 16 position each set. the detention time are adjustable respectively;
- d. The self-learning function of the locus. 3 loci, the time length of each locus is more than 120 seconds with powerless memory;
- e. Character Overlapping. The humane structure of the menu makes all setups and programming of the dome camera more convenient and easy.
- f. Angle display. The dome could display the panning angle, tilting angle and the view angle of the camera.
- g. Proportional pan function. The speed dome will depend on the amount of zoom. At telephoto zoom settings, the pan and tilt speeds will be slower for a given amount of joystick deflection than at wide zoom settings. This keeps the image from moving too fast on the monitor when there is a large amount of zoom. This slowing does not happen when going to a preset, but does occur in turbo mode when high zoom is selected. The minimum pan and tilt speeds are 0.1 degree per second at full zoom.
- h. The Integrated Multi-Protocol. Multiple communication protocols are integrated inside the dome camera with selectable baud rate from 2400 bps to 19200 bps.
- i. Electrify Return. Electrify return to the situation before shut.
- j. Menu Password Protection function. Input password to enter the menu, such function ON/OFF for optional.
- k. The dome title display. The dome title could be set to display in the dome menu.
- l. Temperature display. The temperature could be set to display in the dome menu.
- m. Alarm Function. Four-channel Alarm Input, One-channel Alarm Output.
- n. Long-distance Address Modify Function. To modify the dome address by RS485.

Principle: we call “hard ID (HID)” that setting by the Dip-switcher, and “Soft ID (SID) that setting by the Long-distance address modify. The HID and the SID are same in leaving factory. For example: Camera No.001, HID=SID=001, we change the SID=002 by RS485, so we should select the No. 002 to control it, and the SID address will be remember after shut. And if we change the HID=003 by Dip-switcher, the HID and the SID will be both change to HID=SID=003

### 4. Functions of the Camera

- a. Description of the Focus Control Mode: the user can adjust the focus of the camera manually. When the camera is on near focus, the icon  appears on the screen; when on the nearest state, the icon  appears while on the far focus, the icon  appears.
- b. Description of Backlight Compensation: when the object to be shot is dark and looks dim, the user can open the backlight compensation according to actual need. and the icon  appears on the screen.
- c. Description of White Balance: when the image has color distort on the screen, the user can set different modes by orders. There are 6modes for options: Indoor Mode  Outdoor Mode  Touch Mode  Automatic Trace of White Balance ATW Manual WB-MAN Automatic Mode.
- d. Description of ZOOM Control: user can “pull near” or “push far” the lens according to actual conditions, and the symbol  appears on the screen in which the front part means optical multiplication while the rear part means digital multiplication.
- e. Electron shutter: it is 1/50 sec after the camera electrified, and it will display 50 on the monitor.
- f. AE Mode: setup of Manual/Automatic.
- g. Zero Illuminance: It is used only when the external brightness is extremely low. Normally the camera works on the automatic state. In case the external brightness is lower than 1Lux, the camera can be switch to the Zero Illuminance state automatically and icon  appears on the screen. You can also set the Zero Illuminance state manually.

## III. Setup of the Menu of the Dome Camera

### 1. Basic Operation of the Menu

- 1.1 Open the main menu of the setup by the keyboard or the matrix via the operation “Call No. 64 preset position or No.95 preset position”. Besides that, continuously call No.1 preset position twice in 4 seconds, you can also open the menu; Through setting No.64 preset position in order to close the munu.
- 1.2 When the menu is displayed on the screen, operate “TILT UP”, “TILT DOWN” to move the cursor to the option to be set, operate “PAN LEFT”, “PAN RIGHT” to modify the content or the order to enter this option.
- 1.3 All setups on the menu couldn’t be lost even power failure happens.

### 2. Setup of the Menu

#### 2.1 MAIN MENU

##### 2.1.1 SYSTEM SETUP.

2.1.2 DISPLAY SETUP: to enter the submenu of display of the screen by which ID display, title display of preset point and display of camera screen can be set.

2.1.3 CAMERA SETUP: to enter the submenu of setup of normal data of camera.

2.1.4 MOTTON SETUP: to enter the setup of enhanced function of dome camera.

2.1.5 PRIVACY MASK: to enter the submenu of the camera privacy function setting.

2.1.6 ADVANCE SETUP.

2.1.7 SYSTEM RESET: to reset the system. The dome will make self-checking function after it carries out reset function,the station for the dome's reset is : AUTO FLIP -ON/PTZ SPD RATE-ON/ ID DISPLAY-ON/ANGLE DISPLAY-OFF/ DOME LABEL DISPLAY-OFF/ D-ZOOM-OFF/ PT INTERLOCK -AF AUTO/BLC-OFF/ AUTO HOME -OFF/ PARK TIME -4MIN/FAN-AUTO/ TIMP DISPAY-OFF.

2.1.8 EXIT: to quit the main menu.

MAINMENU	
1.<SYSTEM SETUP>	
2.<DISPLAY SETUP>	
3.<CAMERA SETUP>	
4.<MOTION SETUP>	
5.<PRIVACY MSK>	
6.<ADVANCE SETUP>	
7.SYSTEM RESET	
8.EXIT	

## 2.2 SYSTEM SETUP

2.2.1 SYSTEM INFORMATION: to display the system information.

2.2.2 AUTO FLIP: to ON/OFF the dome 180 ° auto flip.

2.2.3 PROP PAN SPD: to ON/OFF the proportional pan function.

2.2.4 RESERVED : This function seting also kept for thsi products.

2.2.5 ALARM SETUP:

2.2.5.1 ALARM NO: to select the alarm channel.

2.2.5.2 ACTION: to select the action after alarm. The ACTION could be the preset “1-50”, PATROL 1, SCAN 1, PATT 1. The “1-50” are the preset number, PATROL 1 is the patrol No.1, SCAN 1 is the scanning No.1and the PATT 1 is the pattern No.1. After 3 seconds of the alarm function be cancelled ,it will return to the original alarm station.

2.2.5.3 ALARM: to ON/OFF the alarm for each channel.

SYSTEM SETUP	
1.SYSTEM INFORMATION	
2.AUTO FLIP:	ON
3.PROP PAN SPD:	ON
4.RESERVED:	N/A
5.<ALARM SETUP>	
6.RETURN	



SYSTEM INFORMATION	
CAMERA SN:	000000
CAMERA ID :	001
PROTOCOL :	P003
BAUD RATE:	2400BPS
MODEL :	S100P
VERSION :	1.00



SYSTEM SETUP	
1.SYSTEM INFORMATION	
2.AUTO FLIP:	ON
3.PROP PAN SPD:	ON
4.RESERVED:	N/A
5.<ALARM SETUP>	
6.RETURN	

ALARM SETUP	
1.ALARM NO:	001
2.ACTION:	001
3.ALARM:	ON
4.RETURN	

2.2.5.4 RETURN: to return to the SYSTEM SETUP menu.

2.2.6 RETURN: to return to the main menu.

### 2.3 DISPLAY SETUP

2.3.1 CAMERA ID: when it is set at ON, address of dome camera appears on the screen such as “CAM 001”. The default setting is ON.

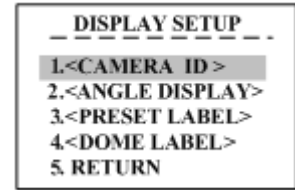

2.3.1.1 DISPLAY: to ON/OFF the dome address.

2.3.1.2 POSITION: to set the position of dome address, there are four positions to be displayed: TOP-L (top-left corner), TOP-R

(top-right corner), BOTT-R (bottom-right corner) AND BOTT-L (bottom-left corner).

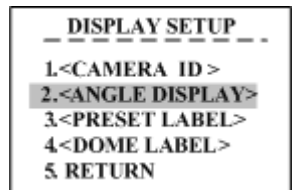

2.3.1.3 RETURN: to return to the DISPLAY SETUP menu.

2.3.2 ANGLE DISPLAY: to enter the angel display submenu.

2.3.2.1 DISPLAY: to ON/OFF the angle display. ONEPUSH singly displayed, auto disappeared in 4 seconds.

2.3.2.2 POSITION: to set the display position of the angle: TOP/BOTTOM.

2.3.2.3 RETURN: to return to the DISPLAY SETUP menu.

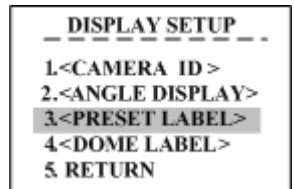

2.3.3 PRESET LABEL: to enter the PRESET LABEL submenu.

2.3.3.1 DISPLAY: to ON/OFF the display of the preset label. If it is ON, the preset label will be displayed on the left of the monitor when the preset position is setting.

2.3.3.2 POSITION: to set the display position of the preset label: TOP-at the top of the monitor, BOTTON- at the bottom of the monitor.

2.3.3.3 RETURN: to return to the DISPLAY SETUP menu.

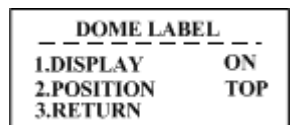
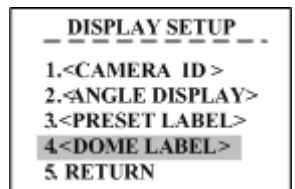

2.3.4 DOME LABEL: to enter the DOME LABEL submenu.

2.3.4.1 DISPLAY: to ON/OFF the display of the dome label.

2.3.4.2 POSITION: to set the display position of the dome label:  
 TOP-at the top of the monitor, BOTTON- at the bottom of the monitor.

2.3.4.3 RETURN: to return to the DISPLAY SETUP menu.

2.3.5 RETURN: to return to MAIN MENU.

**2.4 CAMERA SEUP: If setting camera parameter is N/A, it**

**Me ansthe camera can not support this function.**

CAMERA SETUP	
1.D-ZOOM	OFF
2.DISPLAY	N/A
3.FOCUS MODE:	MANUAL
4.ICR	AUTO
5.BLC	ON
6.L-SYNC	N/A
7.SLOW SHUTTER	ON
8.<WB/AE SETUP>	
9.RETURN	

2.4.1 D-ZOOM: to ON/OFF the digital zoom.

2.4.2 DISPLAY: to ON/OFF the display of the camera information.

2.4.3 FOCUS MODE: NON: iris & focus invariably / A-AUTO: Auto iris / F-AUTO: Auto focus / AF-AUTO: Auto iris and focus.

2.4.4 ICR: to set the AUTO/DAY/NIGHT situation.

2.4.5 BLC: to ON/OFF the back light compensation.

2.4.6 L-SYNC: to ON/OFF the external synchronization. (Only for some special cameras.)

2.4.7 SLOW SHUTTER: frame accumulation with two options Manual/Automatic. When camera screen is opened under automatic state, ASS displays on screen. (Only sony camera has this function)

**2.4.8 WB/AE SETUP.**

CAMERA SETUP	
1.D-ZOOM	OFF
2.DISPLAY	N/A
3.FOCUS MODE:	MANUAL
4.ICR	AUTO
5.BLC	ON
6.L-SYNC	N/A
7.SLOW SHUTTER	ON
8.<WB/AE SETUP>	
9.RETURN	

2.4.8.1 AE MODE: to set the automatic exposure to MANU/AUTO/SHUTTER mode; SHTTER: it is only available at the AE MODE is SHUTTER.



2.4.8.2 WB MODE: to set the white balance mode: ATW / MANUAL / AUTO / INDOOR / OUTDOOR / ONEPUSH;

WB/AE SETUP	
1.AE MODE:	AUTO
SHUTTER:	N/A
2.WB MODE:	AUTO
R GAIN:	N/A
B GAIN:	N/A
3.WDR MODE:	ON
4.<EXPCOMP SETUP>	
5.RETURN	

R GAIN: it is only available for plusing red at the WB MODE Is MANUAL.

B GAIN: it is only available for pulsing blue at the WB MODE is MANUAL.

2.4.8.3 WDR MODE: to ON/OFF the Wide Dynamic Range mode.

EXPCOMP SETUP	
1.EXPCOMP:	ON
2.AMOUNT:	-7
3.RETURN	

2.4.8.4 EXPCOMP SETUP : exposure-compensation.

2.4.8.5 EXPCOMP: exposure-compensation.

2.4.8.6 AMOUNT: the value of exposure-compensation:-7 - +7.

2.4.8.7 RETURN: to return to the WB/AE SETUP menu.

2.4.9 RETURN: to return to the MAIN MANU.

## 2.5 MOTION SETUP

2.5.1 PRESETS: to enter the Preset Position submenu.

2.5.1.1 PRESET NO: to edit the preset number.

2.5.1.2 EDIT LABEL: to edit the preset label. After entering the edit mode, 1-128 present positions. It displayed on screen as the pictures: in the picture, “PRESET NO” stands for NO.1 present

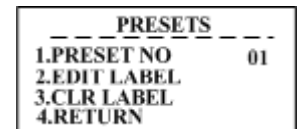
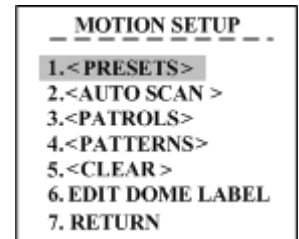

position, the topic is “NO LABEL”. Using PANLEFT/RIGHT can remove the cursor, TILT UP/DOWN can modify the number, press the “CLOSE”, exit edit mode and save it. The topics of the present positions includes 10 characters at most, they are 0-9, A-Z, blank and special characters including = ? , @\+, -. / ] etc. Notes: the first letter must be from 0-9 or A-Z, in case that, it stands for canceling the preset position topic. When testing the preset position, it only display “NO.XXX”, not display the toptic.

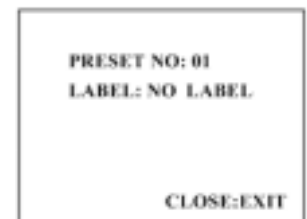

2.5.1.3 CLR LABEL: to clear the preset label.

2.5.1.4 RETURN: to return to the PROGRAM SETUP submenu.

2.5.2 AUTO SCAN: to enter the Auto Scanning submenu:

2.5.2.1 SCAN NO: to set the auto scanning number, maximum is 03.

2.5.2.2 SPEED: to set the scanning speed for each patrol.

2.5.2.3 SET START LIMIT: to set the start position of the scanning. After the user enter this item, to use the joystick to move the dome camera and press “CLOSE” to save the current position.

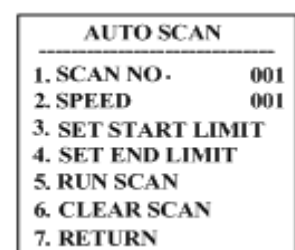
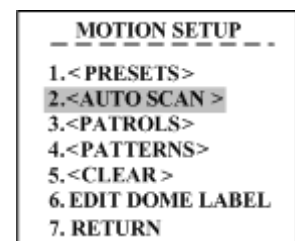



2.5.2.4 SET END LIMIT: to set the end position of the scanning. After the user enter this item, to use the joystick to move the dome camera and press “CLOSE” to save the current position.

2.5.2.5 RUN SCAN: to run the scanning function, Please set the start and end position first. And if the start and end position are the same. The dome camera will scanning for 360 °. To press “CLOSE” to exit.

2.5.2.6 CLEAR SCAN: the clear the setting of the scanning, to press “CLOSE” to exit.

2.5.2.7 RETURN: to return to the PROGRAM SETUP menu.

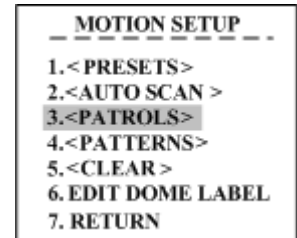

2.5.3 PATROLS: to enter the submenu to set the patrols.

2.5.3.1 PATROL NO: to set the patrol number.

2.5.3.2 EDIT PATROL: to set the parameter of the patrol, after enter this item, the monitor is as following:

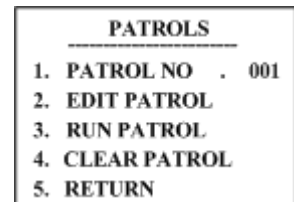

NO	POS	TM	NO	POS	TM
01	001	01	02	001	01
03	003	01	04	001	01
05	---	---	06	---	---
07	---	---	08	---	---
09	---	---	10	---	---
11	---	---	12	---	---
13	---	---	14	---	---
15	---	---	16	---	---

PATROL:01 CLOSE:EXIT

NO - Patrol number  
 POS - Preset number  
 TM - Stop time

After entering into edit area, screen shows as follows:  
 Edit Area, data of 2 patrol position appears on one line.

PATROL:01 - It means the set No.1 patrol  
 CLOSE:EXIT - Press CLOSE to exit edit state

Both top and bottom lines display prompt and information of each patrol is displayed on the middle of the screen. **Data of 2 Patrol points appears on one line.**

And to press PAN LEFT/RIGHT to move the cursor, to press TILT UP/DOWN to modify the data, to press “CLOSE” to save and quit the edit state.

2.5.3.3 RUN PATROL: to run the patrol, press “CLOSE” to exit.

2.5.3.4 CLEAR PATROL: to clear the patrol.

2.5.3.5 RETURN: to return to the PROGRAM SETUP menu.

2.5.4 PATTERNS: to enter the PATTERN setting submenu.

2.5.4.1 PATTERNS: to edit the pattern number. No 1-3 for optional.

2.5.4.2 RECORD PATTERN: to record the pattern, and press “CLOSE” to exit.

2.5.4.3 RUN PATTERN: to run the pattern, and will quit the menu automatically, and any move of the joystick will stop this function.

2.5.4.4 CLEAR PATTERN: to clear the setting of the pattern.

2.5.4.5 RETURN: to return to the superior menu.

2.5.5 CLEAR: to enter the CLEAR submenu.

2.5.5.1 CLEAR ALL PRELABEL: to clear all the preset positions.

2.5.5.2 CLEAR ALL SCAN: to clear all the scanning.

2.5.5.3 CLEAR ALL PATROLS: to clear all the patrols.

2.5.5.4 CLEAR ALL PATTERNS: to clear all the patterns.

2.5.5.5 RETURN: to return to the PREGRAM SETUP menu.

2.5.5.6 EDIT DOME LABEL: To edit the dome label. Set a label for each dome, the label is make up of 10 characters, and the optional character is the same as 2.5.1.2.

2.5.7 RETURN: to return to the MAIN MENU.

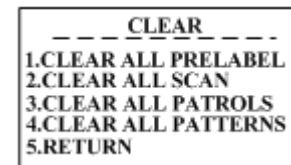
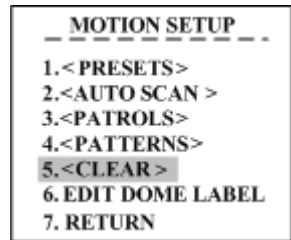
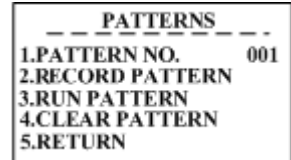
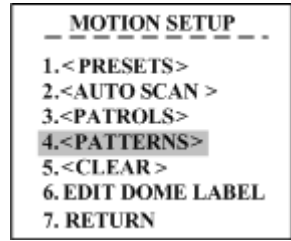

**2.6 PRIVACY MASK:**

2.6.1 PRIVACY MASK: to set the privacy number. 1-4 for optional.

(different cameras have different choose)

2.6.2 MASK SHADE: to set the color of the mask area.

2.6.3 DISPLAY: to ON/OFF the privacy function

2.6.4 EDIT MASK: to edit the mask area.

2.6.5 RETURN: to return to Main Menu.

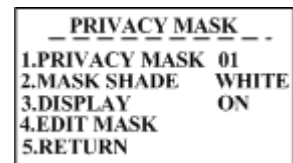

**2.7 ADVANCE SETUP:**

2.7.1 HOME SETUP: to enter the auto home submenu.

2.7.1.1 AUTO HOME: to set ON to open the AUTO HOME function, it is mean the dome camera will back to the home position without any action in the PARK TIME. And set OFF to close this function.

2.7.1.2 HOME ACTION: to set the auto home point. For example: if the user want to set one scene to be the HOME, just set the dome camera to this scene, and set it to be the preset No:3, then open this menu, set the HOME ACTION to be “3”. And don’t forget to set the AUTO HOME to be ON. The HOME ACTION could be the preset “1-50”, RESUME, PATROL 1, SCAN 1, PATT 1. The “1-50” are the preset number, RESUME is mean to back to the scene before the manual control, PATROL 1 is the patrol No.1, SCAN 1 is the scanning No.1 and the PATT 1 is the pattern No.1.

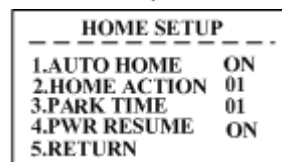
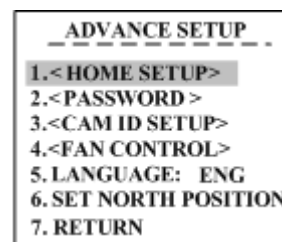

2.7.1.3 PARK TIME: to set the park time of the dome camera, it is mean how long the dome camera will be back to the HOME. The time from 1-99 minutes.

2.7.1.4 PWR RESUME: to ON/OFF the function, which the dome camera will be back to the scene before the power off.

2.7.1.5 RETURN: to return to the ADVANCE SETUP Menu.

2.7.2 PASSWORD: to enter the password setting menu. (Initial password is 111111.)

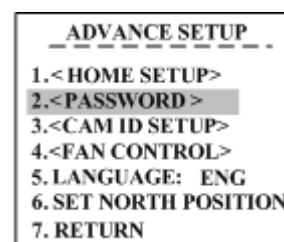

2.7.2.1 PASSWORD: to ON/OFF the password protection.

2.7.2.2 MODIFY KEY: to enter the new password.

2.7.2.3 CONFIRM KEY: to enter the new password again for confirm.

2.7.2.4 RETURN: to return to the ADVANCE SETUP menu.

2.7.3 CAM ID SETUP: to enter the soft ID setting submenu.

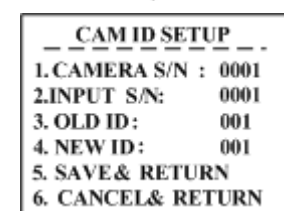
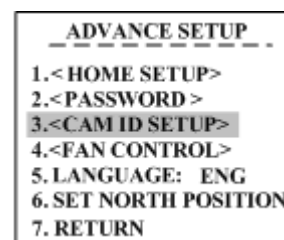

2.7.3.1 CAMERA S/N: to display the series number of the dome.

2.7.3.2 INPUT S/N: to input the series number of the dome.

2.7.3.3 OLD ID: to display the old address of the dome.

2.7.3.4 NEW ID: to display the new address of the dome. Input the series number before inputting the new address.

2.7.3.5 SAVE & RETURN: to save and return to the ADVANCE SETUP menu.

2.7.3.6 CANCEL & RETURN: to cancel and return to the ADVANCE

SETTING menu.

2.7.4 FAN CONTROL: to enter the fan control setting submenu.

2.7.4.1 FAN: to set the work condition of the fan: ON / OFF / AUTO.

2.7.4.2 OPEN TEMP: to set the work temperature of the fan under AUTO condition.

2.7.4.3 Temperature Fahrenheit / Celsius display switch.

2.7.4.4 TEMP DISPLAY: to ON/OFF the display of the temperature.

2.7.4.5 RETURN: to return the ADVANCE SETUP menu.

2.7.5 LANGUAGN: to select the language.

2.7.6 SET NORTH POSITION.

2.8 **EXIT**: to exit the main menu.

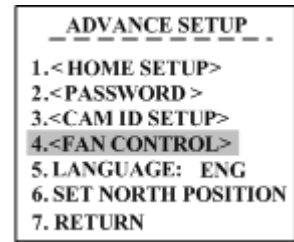

## . Setup of the Dome Camera

### 1. Connection of the System

1) The Systematic Drawing of the Dome Camera

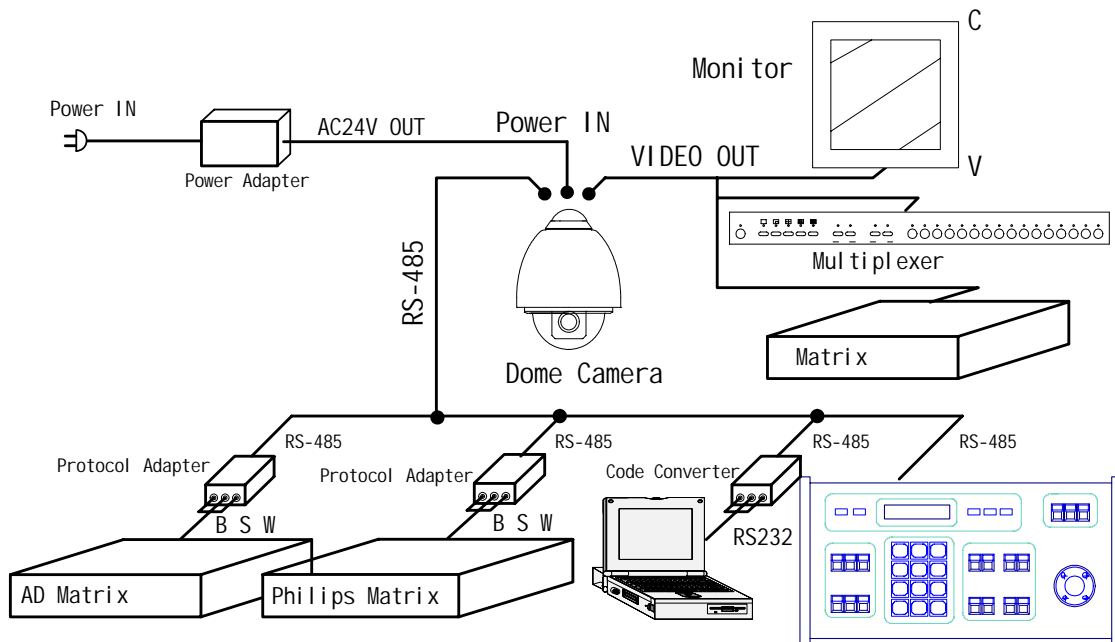

Figure

1

2) Address / Protocol Coding Switch Drawing

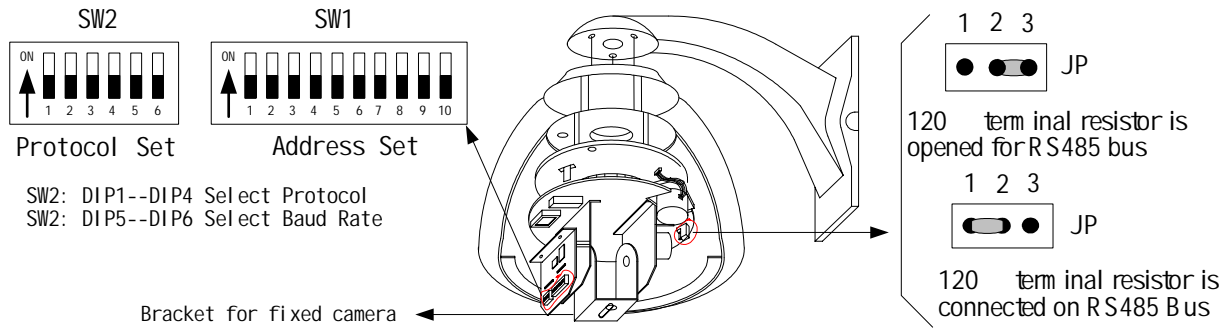

Figure 2

2. **Setup of Coding Switch of Dome Camera.** As shown in Figure 2, SW1 is used to set address of the dome camera from 1 – 1023. The ID-CODE from DIP-10 to DIP-1 are equivalent to a 10-bit binary digit. DIP-10 is MSB while DIP-1 is LSB. The state “ON” of each bit means 1 while “OFF” means 0. Following table shows states of coding switches of some addresses.

Dome Address	ID-CODE Status									
	DIP-1	DIP-2	DIP-3	DIP-4	DIP-5	DIP-6	DIP-7	DIP-8	DIP-9	DIP-10
1	ON	OFF	OFF	OFF	OFF	OFF	OFF	OFF	OFF	OFF
2	OFF	ON	OFF	OFF	OFF	OFF	OFF	OFF	OFF	OFF
3	ON	ON	OFF	OFF	OFF	OFF	OFF	OFF	OFF	OFF
4	OFF	OFF	ON	OFF	OFF	OFF	OFF	OFF	OFF	OFF
5	ON	OFF	ON	OFF	OFF	OFF	OFF	OFF	OFF	OFF
6	OFF	ON	ON	OFF	OFF	OFF	OFF	OFF	OFF	OFF
7	ON	ON	ON	OFF	OFF	OFF	OFF	OFF	OFF	OFF
8	OFF	OFF	OFF	ON	OFF	OFF	OFF	OFF	OFF	OFF
9	ON	OFF	OFF	ON	OFF	OFF	OFF	OFF	OFF	OFF
10	OFF	ON	OFF	ON	OFF	OFF	OFF	OFF	OFF	OFF
11	ON	ON	OFF	ON	OFF	OFF	OFF	OFF	OFF	OFF
12	OFF	OFF	ON	ON	OFF	OFF	OFF	OFF	OFF	OFF
13	ON	OFF	ON	ON	OFF	OFF	OFF	OFF	OFF	OFF
14	OFF	ON	ON	ON	OFF	OFF	OFF	OFF	OFF	OFF
15	ON	ON	ON	ON	OFF	OFF	OFF	OFF	OFF	OFF
16	OFF	OFF	OFF	OFF	ON	OFF	OFF	OFF	OFF	OFF
17	ON	OFF	OFF	OFF	ON	OFF	OFF	OFF	OFF	OFF
18	OFF	ON	OFF	OFF	ON	OFF	OFF	OFF	OFF	OFF
...	...	...	...	...	...	...	...	...	...	...
1023	ON	ON	ON	ON	ON	ON	ON	ON	ON	ON

Table 1

For Example:

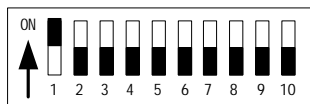

Speed Dome Address=1

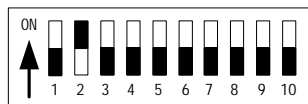

Speed Dome Address=2

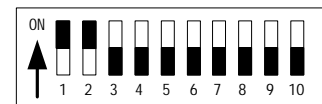

Speed Dome Address=3

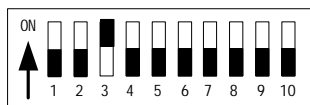

Speed Dome Address=4

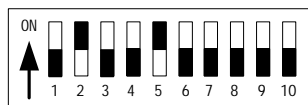

Speed Dome Address=18



Speed Dome Address=1023

3. **Setup of the Protocol and the Default Baud Rate.** As shown in Figure 2, SW2 is used to set the protocol of communication and the baud rate used by the dome camera. DIP-4 to DIP-1 of SW2 is used to select protocols and 16 different protocols can be selected in

maximum. Following table shows states of coding switches of protocols selected by the dome camera

Protocols	Protocol Settings				Baud rate	
	DIP-1	DIP-2	DIP-3	DIP-4	DIP-5	DIP-6
B01	ON	OFF	OFF	OFF	OFF	ON
Santachi	OFF	ON	OFF	OFF	OFF	ON
PELCO-P/D	ON	ON	OFF	OFF	OFF	OFF
PELCO-MK	OFF	OFF	ON	OFF	OFF	OFF
PANASONIC	ON	OFF	ON	OFF	OFF	ON
Longcomity	OFF	ON	ON	OFF	OFF	ON
HUNDA600	ON	ON	ON	OFF	OFF	ON
LILIN	OFF	OFF	OFF	ON	OFF	ON
VICON	ON	OFF	OFF	ON	ON	OFF
MOLYNX	OFF	ON	OFF	ON	OFF	ON
KALATEL	ON	ON	OFF	ON	ON	OFF
VCL	OFF	OFF	ON	ON	OFF	ON
SAMSUNG	ON	OFF	ON	ON	OFF	ON
ALEC	OFF	ON	ON	ON	OFF	ON
Ultrak	ON	ON	ON	ON	OFF	ON

Table 2

Some protocols and the states of the coding switches of normal baud rate of these protocols are shown as follows:

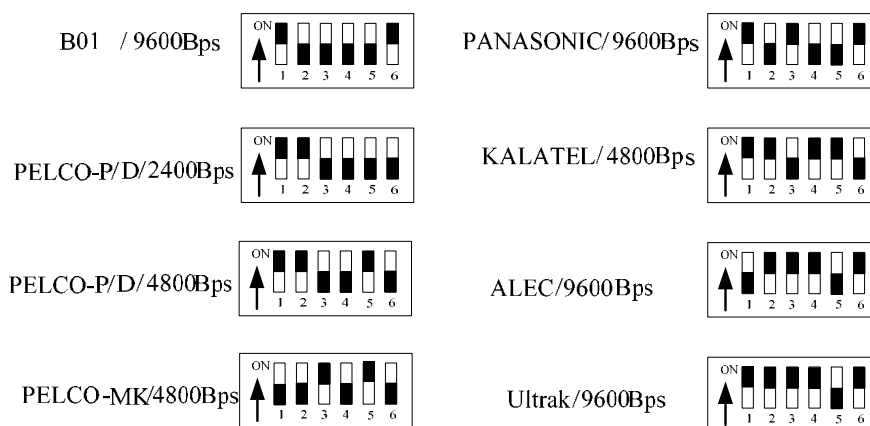

**4. Setup of the Baud Rate of Communication.** As shown in Figure 2, SW2 is used to set the protocol of communication and the baud rate used by the dome camera. DIP-6 and DIP-5 of SW2 are used to select the baud rate of communication and 4 different baud rates can be selected in maximum. If the controller adopts non-standard baud rate, you can adjust it to be identical with that of the controller as per the following table.

Baud Rate of Communication	DIP-1	DIP-2	DIP-3	DIP-4	Setup of Baud Rate	
					DIP-5	DIP-6
2400bps					OFF	OFF
4800bps					ON	OFF

## Operation Manual for Intelligent Speed Dome Camera

9600bps					OFF	ON
19200bps					ON	ON

5. **Selection of the Terminal Resistor of the Dome Camera.** As shown in Figure 2, JP is the select switch of the 120 Ω terminal resistor on the bus RS485, on which only one terminal resistor of the dome camera at the farthest end can be connected, while the terminal resistors of other devices should be opened.

### 6. Shortcut control function

Preset	Set Preset	Call Preset
1	Reserved	Twice Call Preset Open the menu
64	Close the menu	Open the menu
90	Reserved	Reserved
91	1080i/59.94(Initial setting)	Run patro
92	720p/59.94	Scan limit to left
93	NTSC(CROP)	Scan limit to right
94	NTSC(SQ)	Reserved
95	1080i/50	Open the menu
96	720p/50	Stop scan
97	PAL(CROP)	Auto scan
98	PAL(SQ)	Reserved
99	Reserved	Reserved

## • The Installation of the System

### 1. The style of the Installation

#### 1) Dimension of the Product

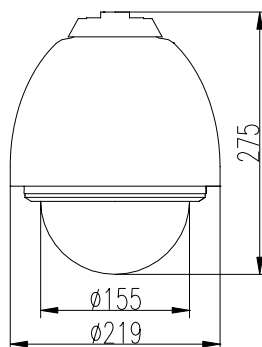

Figure 3

#### 2) The Style of Installation

##### a) Wall Installation

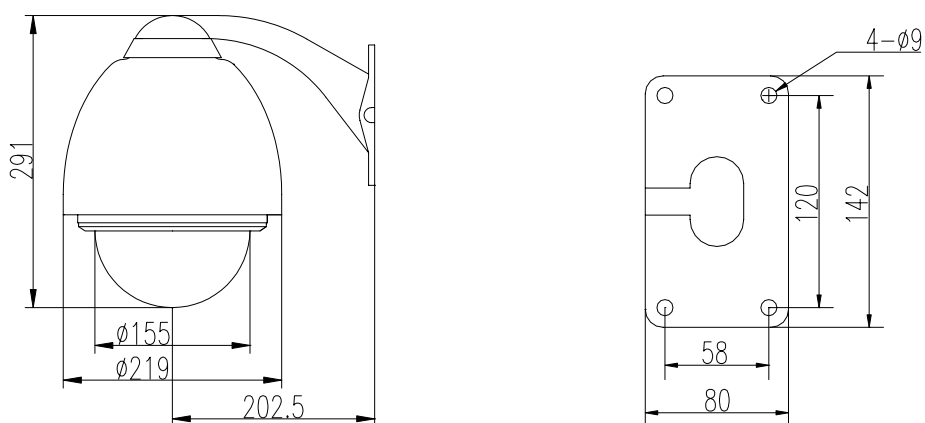

Figure 4

b) In-Ceiling Installation

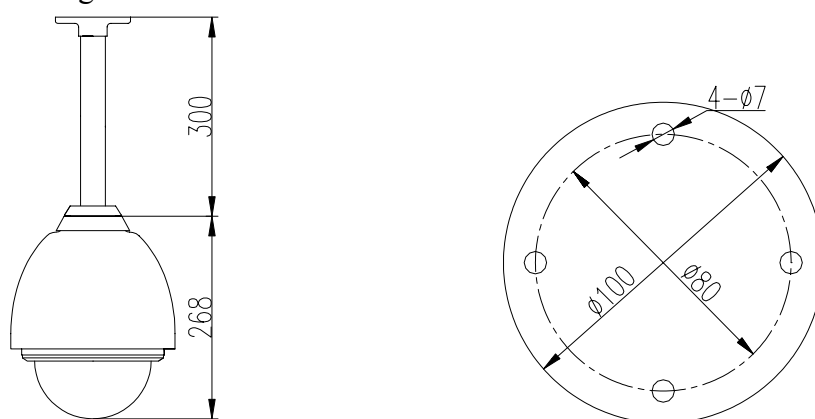

Figure 5

**2. Steps of Installation (taking wall-mounting as example)**

- 1) Unpacking the carton and carefully take out the dome camera and its attachments.
- 2) Rotate the vitreous cover counterclockwise and take out it. (see Figure 6) Note: It can be ignored the steps 2,3,4,5 while the protocol and address are matching with the controller.
- 3) Take out the black liner. (Figure 7)
- 4) Based on the ID-CODE shown as Figure 2, set up the protocol used by the camera and the baud rate as per the state according to Table 1. Check the address of the camera to see if it is matched with that you need. If not, set the address of the dome camera at corresponding position as per Table 1.



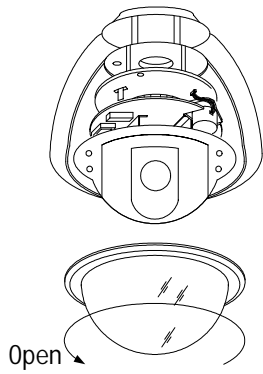

Figure 6

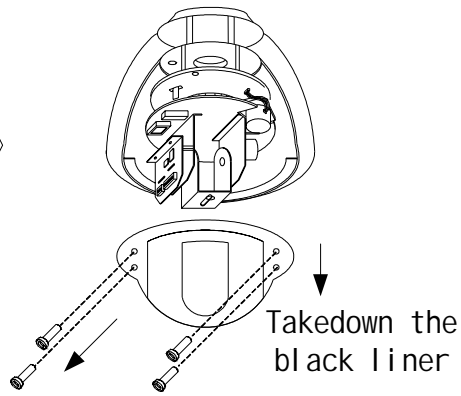

Figure 7

- 5) Fix the black liner (see Figure 8).

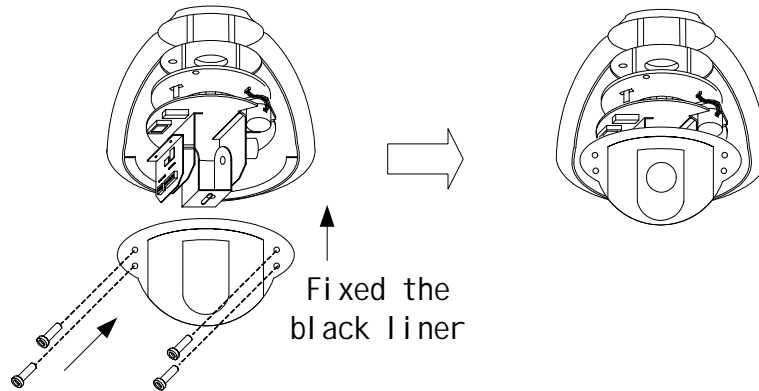

Figure 8

- 6) Take out the cover of the wall-installed bracket. ( Figure9 )  
7) Take out system control wires from the bracket ( Figure 10 ) .  
8) Fix the bracket on the wall ( Figure11 ) .

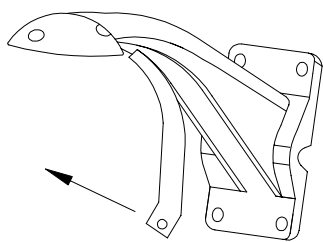

Figure 9

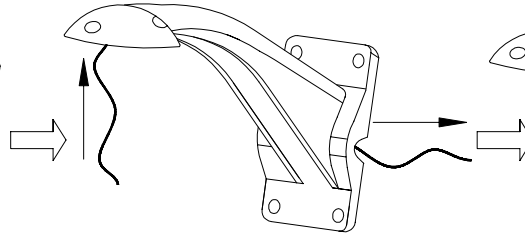

Figure 10

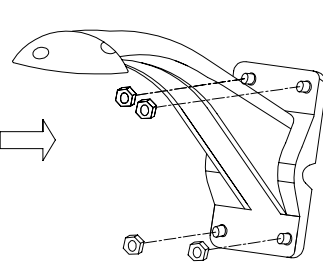

Figure11

- 9) Aiming the "MARK" of the bracket to the "MARK" of the flange, push the dome upward to the end and rotate it with the direction of the arrow until it is clicked and tightened. ( Figure 12 ) .  
10) It's ok to fix the dome to the bracket with hexagon socket head cap screw( Figure 13 ) .

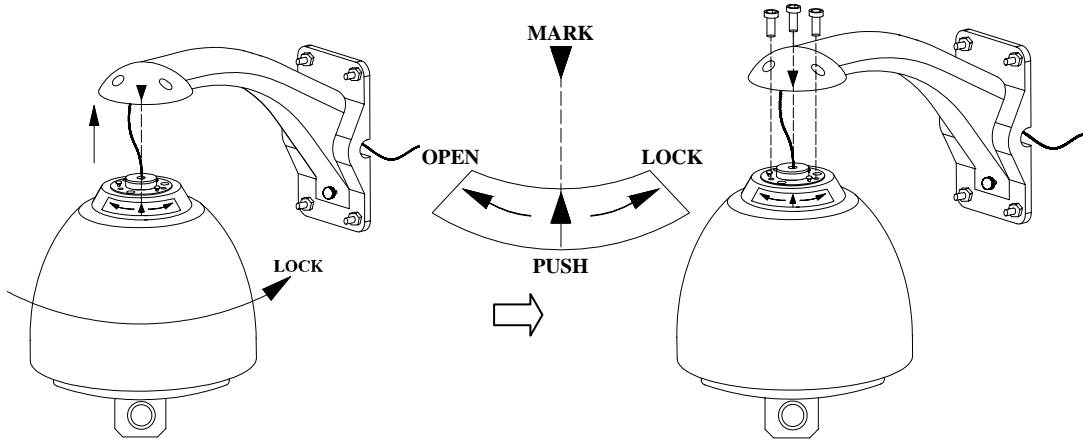

Figure 12

Figure 13

11) Rotate the vitreous cover clockwise and mount it ( Figure 14 )

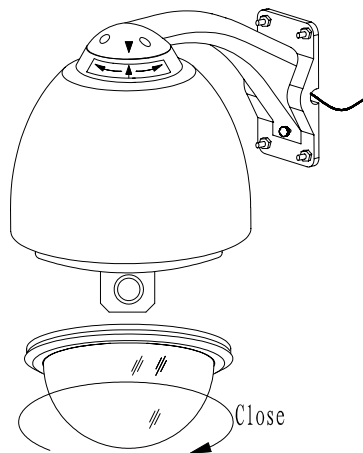

Figure 14

12) Connect the control wires of the system as per Figure 15.

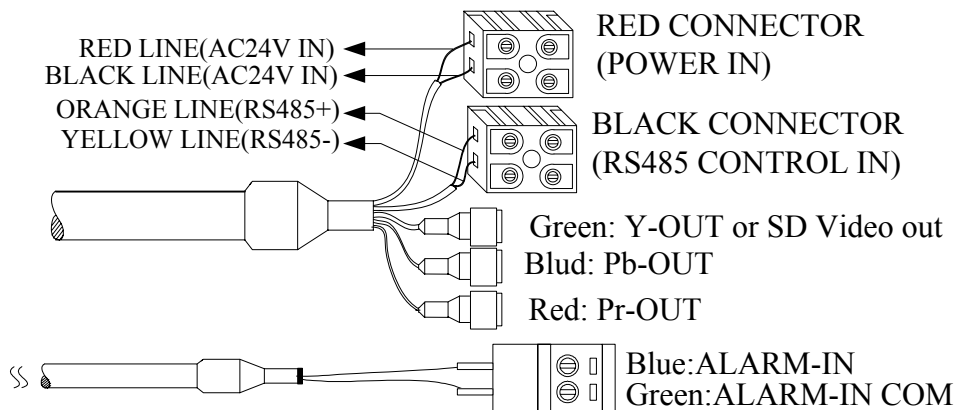

Figure 15

### 3 . Steps of Installation for Indoor Ceiling Style

- 1) Unpacking the carton and carefully take out the dome camera and its attachments .
- 2) Take out of the bracket, and fix the bracket on the wall. ( Figure16 ) .
- 3) Please connect the system control wires, video wires, power wires with the bracket and go through it. Aiming the "MARK" of the bracket to the "MARK" of the flange, push the dome upward to the end and rotate it with the direction of the

arrow until it is clicked and tightened ( Figure17 ) .

- 4) And then, please fix the dome to the bracket with bolts. ( Figure18 ) .

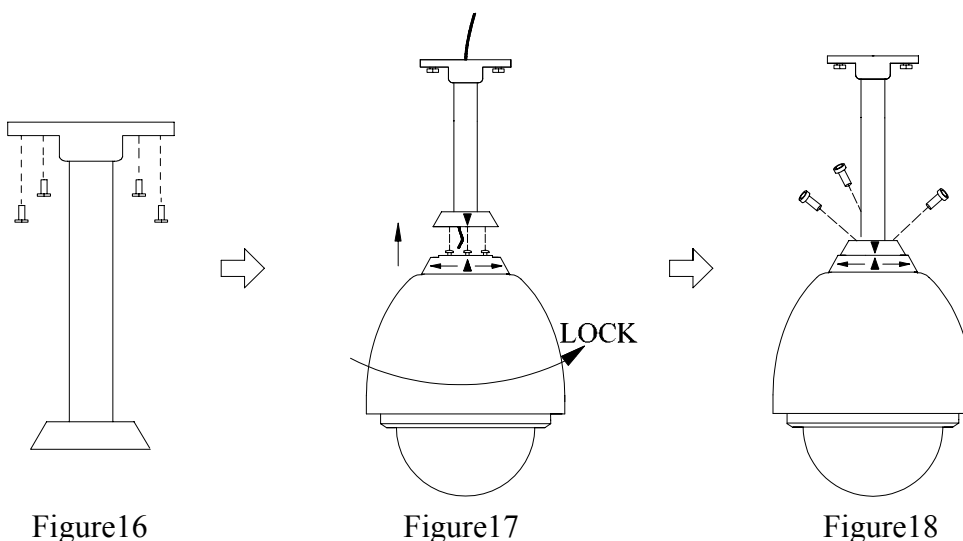

**4 . To ensure a smooth and successful installation, you must:**

- 1) Have electrical work comply with latest national electrical code, national fire code, and all applicable local codes and ordinances.
- 2) Coordinate work with other trades to avoid interference.
- 3) Verify existing site conditions and coordinate with owner’s representative and appropriate utilities as required.
- 4) Obtain copies of all related plans, specifications, shop drawings and addenda to schedule and coordinate related work
- 5) Thoroughly review the project to ensure that all work meets or exceeds the above requirements. Bring alleged discrepancies to the attention of the CCTV Project Coordinator.

**. Technical data table**

1、 Indoor/Outdoor Speed Dome

Power supply	AC24V 50/60Hz
Power consumption	35W max
Sync system	Internal
Preset	128 presets
Patrol	6
Auto pan scan	360°Programmable
Pan Manual Control Speed	0—180°/s
Pan Preset Speed	300°/s max
Pan rotation range	360°continues
Title range	90°
Tilt Manual Control Speed	90°/s
Tilt Preset Speed	120°/s

## Operation Manual for Intelligent Speed Dome Camera

Precision	± 0.1°
Control mode	RS485
Baud Rate	2400/4800/9600/19200 bps
Fan & heater	Fan & heater auto-start (only outdoor dome)
Environment temp	Indoor dome : -5 — +45 Outdoor dome -35 -- +55

### 2、 Camera Optional data table

Effective picture elements	Approx.2,000,000 pixels
Video signal	HD:1080i/59.94, 1080i/50,720p/59.94,720p/50
	SD:NTSC(CROP),NTSC(SQUEEZE),PAL(CROP),PAL(SQUEEZE)
Lens	10X zoom(F1.8 to F2.1)
	F=5.1mm(WIDE) to 51mm(TELE)
Digital zoom	12X(120X with optical zoom)
Angle of view(H)	Approx.50 degree(WIDE end) to Approx.5.4 degree(TELE end)
Min illumination	1.0 Lux ICR On(F1.8) with 50 IRE
S/N ratio	50 dB or more
Iris	Auto/Manu
Focus	Auto/Manu
B.L compensation	ON/OFF
White balance	AUTO/INDOOR/OUTDOOR/ONE PUSH/MANU
Gain Control	Auto/Manu
Exposure compensation	± 10.5dB
Video output	HD: ANALOG COMPONENT(Y/Pb/Pr)
	SD:VBS

### • Troubleshooting

Problem	Probable cause	Solution
On power no action	Power supply fault	Replace
	Bad connection of the power	Make correction
	Transformer damaged	Replace
On power cannot self-check have image but have motor noise	Mechanical failure	Repair
	Camera incline	Reinstall
	Power supply not enough	Replace
Self-check ok, but have no image	Video signal fault	Reinstall
	Bad connection of the video	Press to full connect
	Camera damaged	Replace
Self-check ok but cannot control	RS485 Bus bad connection	Check the RS485 connection
	Dome id setting is wrong	Reselect
	Protocol setting is wrong	Reset and on power again
Vague image	Bad connection of the video	Press to full connect
	Power supply not enough	Replace
On power cannot control	Self check error	On power again
	Bad connection of control	Press to full connect
	Bad control of matrix	On power again

## Appendix : Lightning Proof and Surge Signal Proof

## Operation Manual for Intelligent Speed Dome Camera

The product adopts TVS lightning proof technology to prevent from damage by lightning strike below 1500 W and impulse signals such as surge; but it is also necessary to abide by the following precautions to ensure electrical safety based on practical circumstances:

- Keep the communication cables at least 50 meters away from high voltage equipment or cables.
- Make outdoor cable laying-out under eaves as possible as you can.
- In open area shield cables in steel tube and conduct a single point ground to the tube. Trolley wire is forbidden in such circumstances.
- In strong thunderstorm or high faradic zone (such as high voltage transformer substation), extra strong lightning proof equipment must be installed.
- Take the building lightning proof requirements into account to design the lightning proof and grounding of outdoor equipment and cable laying-out in accordance with the national and industrial standards.
- The system must be grounded with equal potentials. The earth ground connection must satisfy the anti-interference and electrical safety requirements and must not short circuited with high voltage electricity net. When the system is grounded separately, the resistance of down conductor should be  $\leq 4 \Omega$  and the sectional area of down conductor should be  $\geq 25\text{mm}^2$  (refer to Figure 19).

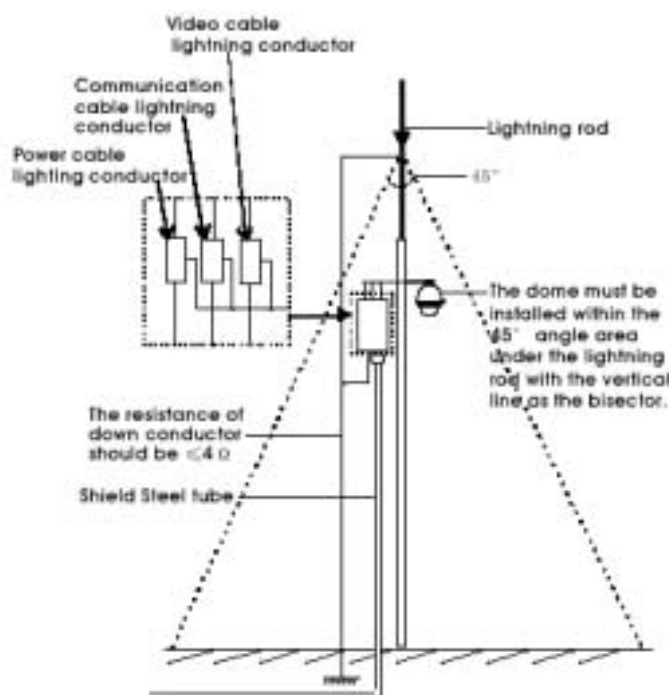

Figure 19

## Appendix : The Cleaning of Clear Down Cover

To obtain constant clear videos, user should clean the down cover periodically.

- Be cautious when cleaning. Hold the down cover ring only to avoid direct touch to the acrylic down cover. The acid sweat mark of fingerprint will corrode the coating of down cover and scratch on down cover will cause vague images.
- Use soft dry cloth or the substitute to clean the inner and outer surfaces.
- For hard contamination, use neutral detergent. Any cleanser for high grade furniture is applicable.

## Appendix : RS485 Bus Basic Knowledge

### 1. Characteristics of RS485 Bus

As specified by RS485 standards, RS485 Bus is of half-duplex data transmission cables with characteristic impedance as 120 . The maximum load capacity is 32 unit loads (including main controller and controlled equipment).

## 2. Transmission distances of RS485 Bus

When user selects the 0.56mm (24AWG) twisted pair wires as data transmission cable, the maximum theoretical transmitting distances are as follows:

Baud Rate	Maximum Transmitting Distance
2400 Bps	1800m
4800 Bps	1200m
9600Bps	800m

If user selects thinner cables, or installs the dome in an environment with strong electromagnetic interference, or connects lots of equipment to the RS485 Bus, the maximum transmitting distance will be decreased. To increase the maximum transmitting distance, do the contrary.

## 3. Connection and termination resistor

The RS485 standards require a daisy-chain connection between the equipment. There must be termination resistors with 120 impedance at both ends of the connection (refer to Figure 20).

Please refer to Figure 21 for simple connection. “D” should not exceed 7m.

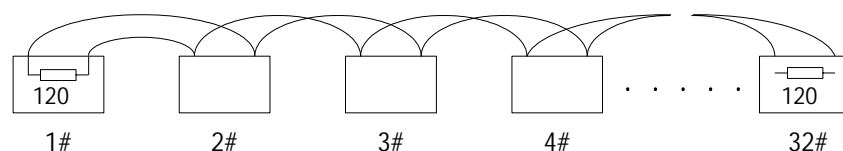

Figure 20

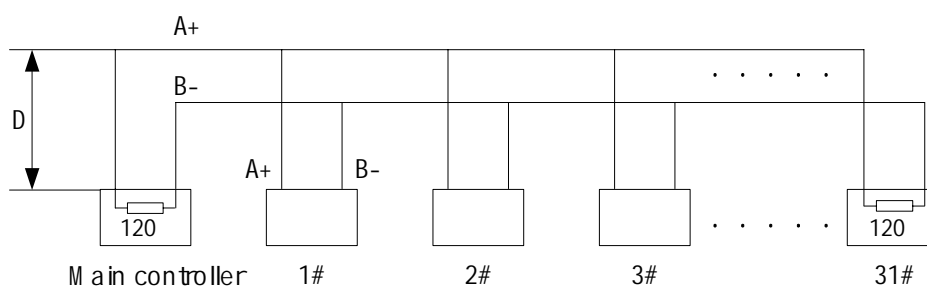

Figure 21

The connection of 120 termination resistor: The termination resistor is ready on the Protocol PCB. There are two kinds of connection. Refer to the Protocol PCB jumper setting form (refer to Picture 2).

- 1) In the Picture it is the factory default connection. The jumper is seated on Pin2&Pin3 and the termination resistor is not connected.
- 2) when connecting the 120 termination resistor, user should plug the jumper on Pin1&Pin2. and the termination resistor is connected.

## 4. Problems in practical connection

In some circumstances user adopts a star configuration in practical connection. The termination resistors must be connected to the two equipment that are farthest away from each other, such as equipment 1# and 15# in Picture 44. As the star configuration is not in conformity with the requirements of RS485 standards, problems such as signal reflections, lower anti-interference performance arise when the cables are long in the connection. The reliability of control signals is decreased with the phenomena that the dome does not respond to or just responds at intervals to the controller, or does continuous operation without stop (refer to Figure 22).

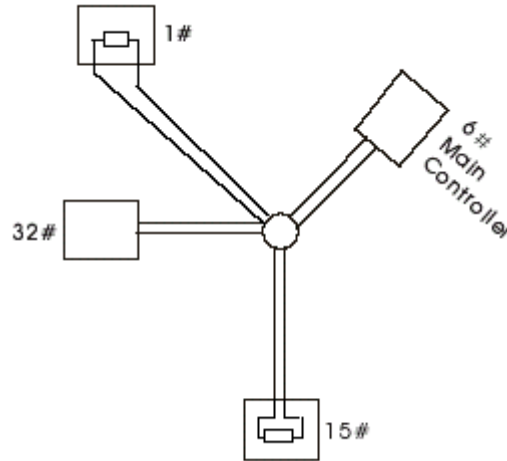

Figure 22

In such circumstances the factory recommends the usage of DR-HB16 RS485 distributor. The distributor can change the star configuration connection to the mode of connection stipulated in the RS485 standards. The new connection achieves reliable data transmission (refer to Figure 23).

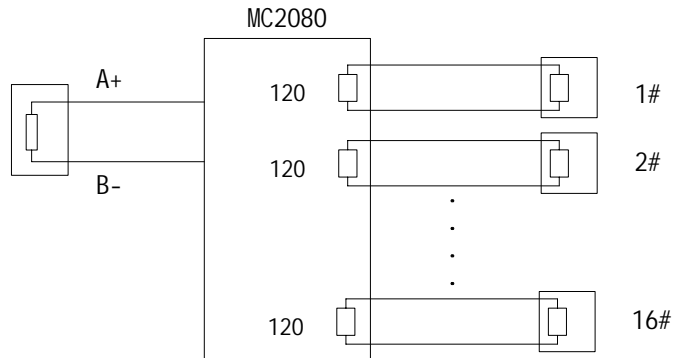

Figure 23

**Appendix :**

**Wire Diameter and Transmission Distance Comparison Chart**

		Wire diameter (mm)			
		0.8000	1.000	1.250	2.000
Transmission Distance feet(m)	Power [VA]				
	10	283 ( 86 )	451 ( 137 )	716 ( 218 )	1811 ( 551 )
20	141 ( 42 )	225 ( 68 )	358 ( 109 )	905 ( 275 )	
30	94 ( 28 )	150 ( 45 )	238 ( 72 )	603 ( 183 )	
40	70 ( 21 )	112 ( 34 )	179 ( 54 )	452 ( 137 )	
50	56 ( 17 )	90 ( 27 )	143 ( 43 )	362 ( 110 )	

## Operation Manual for Intelligent Speed Dome Camera

60	47 ( 14 )	75 ( 22 )	119 ( 36 )	301 ( 91 )
70	40 ( 12 )	64 ( 19 )	102 ( 31 )	258 ( 78 )
80	35 ( 10 )	56 ( 17 )	89 ( 27 )	226 ( 68 )
90	31 ( 9 )	50 ( 15 )	79 ( 24 )	201 ( 61 )
100	28 ( 8 )	45 ( 13 )	71 ( 21 )	181 ( 55 )
110	25 ( 7 )	41 ( 12 )	65 ( 19 )	164 ( 49 )
120	23 ( 7 )	37 ( 11 )	59 ( 17 )	150 ( 45 )
130	21 ( 6 )	34 ( 10 )	55 ( 16 )	139 ( 42 )
140	20 ( 6 )	32 ( 9 )	51 ( 15 )	129 ( 39 )
150	18 ( 5 )	30 ( 9 )	47 ( 14 )	120 ( 36 )
160	17 ( 5 )	28 ( 8 )	44 ( 13 )	113 ( 34 )
170	16 ( 4 )	26 ( 7 )	42 ( 12 )	106 ( 32 )
180	15 ( 4 )	25 ( 7 )	39 ( 11 )	100 ( 30 )
190	14 ( 4 )	23 ( 7 )	37 ( 11 )	95 ( 28 )
200	14 ( 4 )	22 ( 6 )	35 ( 10 )	90 ( 27 )

## APPENDIX : Wire Gauge Conversion Chart

Bare wire diameter metric size ( mm )	AWG (Approximate)	SWG (Approximate)	Bare wire cross sectional area ( mm <sup>2</sup> )
0.050	43	47	0.00196
0.060	42	46	0.00283
0.070	41	45	0.00385
0.080	40	44	0.00503
0.090	39	43	0.00636
0.100	38	42	0.00785
0.110	37	41	0.00950
0.130	36	39	0.01327
0.140	35		0.01539
0.160	34	37	0.02011
0.180	33		0.02545
0.200	32	35	0.03142
0.230	31		0.04115



### Operation Manual for Intelligent Speed Dome Camera

0.250	30	33	0.04909
0.290	29	31	0.06605
0.330	28	30	0.08553
0.350	27	29	0.09621
0.400	26	28	0.1237
0.450	25		0.1602
0.560	24	24	0.2463
0.600	23	23	0.2827
0.710	22	22	0.3958
0.750	21		0.4417
0.800	20	21	0.5027
0.900	19	20	0.6362
1.000	18	19	0.7854
1.250	16	18	1.2266
1.500	15		1.7665
2.000	12	14	3.1420
2.500			4.9080
3.000			7.0683